

CATALOGO  
2023







# LEGENDA SIMBOLI



ESEMPIO:  
L'ATTUALE  
CLASSE A+  
DIVENTA F



TIPOLOGIA  
DI LAMPADINA  
O ILLUMINAZIONE



TIPOLOGIA  
DI ATTACCO



WATT



VOLT



HERTZ



INDICE DI RESA  
CROMATICA



APPARECCHIO  
PRODOTTO SECONDO  
LE DIRETTIVE  
EUROPEE



ENERGY-RELATED  
PRODUCTS



FATTORE DI  
POTENZA



ANGOLO DI LUCE



FORO



DURATA  
DI VITA  
APPARECCHIO



NON  
DISPERDERE  
NELL'AMBIENTE  
DOPO L'UTILIZZO



NON POSSONO  
ESSERE INSTALLATI IN  
APPARECCHI DOTATI  
DI DIMMER O REGOLATI  
DA DIMMER ESTERNI

## ATTACCHI



E27



E14



GU10



G9



G4



MR16



R7S



G13

# INDICE ILLUMINAZIONE



GOCCIA A60/A65  
PAG. 6-11



SFERETTA G45  
PAG. 12-13



CANDELA C35  
PAG. 14



GLOBO G120  
PAG. 15



SPOT R50/R63/R80  
PAG. 16



T35 - T45 - T50  
PAG. 17



DICRO/FLAT  
GU10 - GU5.3  
PAG. 18-19-20



J78 - J118  
PAG. 21

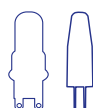

G4 - G9  
PAG. 22-23

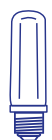

E14  
PAG. 24



FILO LED  
PAG. 25-33



TUBO T8  
PAG. 35



FARO DA  
INCASSO  
PAG. 36-37

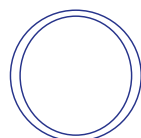

PLAFONIERA  
ESTERNA IP54 - GHIERE  
PAG. 39



PLAFONIERA  
STAGNA IP65  
PAG. 41



FLOODLIGHT  
PAG. 43-49



FARI  
INDUSTRIALI  
PAG. 51

# ELETTRICO



SPINA - PRESA  
BIANCA  
PAG. 53

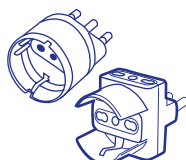

ADATTATORE  
SCHUKO  
BIANCO  
PAG. 54



ADATTATORE -  
PRESA BIANCO  
PAG. 55



SPINA - PRESA  
NERA  
PAG. 56

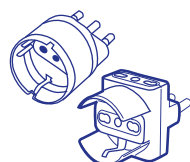

ADATTATORE  
SCHUKO  
NERO  
PAG. 57



SPINA - PRESA  
BIANCA  
FLOW PACK  
PAG. 58

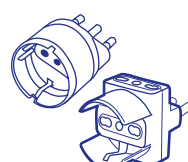

ADATTATORE  
SCHUKO  
BIANCO  
FLOW PACK  
PAG. 59

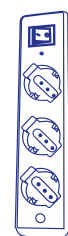

MULTIPRESA  
POLIVALENTE  
PAG. 60-61

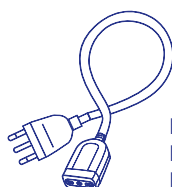

PROLUNGA  
LINEARE  
PAG. 62-63

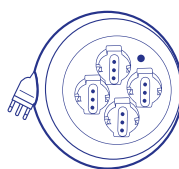

AVVOLGICAVO  
PAG. 64-65



NASTRO  
ISOLANTE  
PAG. 66-67



60 mm  
112 mm

**E27**  
Attacco Grande

Angolo Luce  
160°

≥25.000x

Durata  
25.000 ore

V  
220/240V

Hertz  
50/60Hz



## GOCCIA SENSOR A60 LED

CODICE	WATT	LUMEN	ATTACCO	KELVIN	ENERGY CLASS	DF	EQUIVALENTE		
								INNER	MASTER
● HE178	9	860	E27 -Attacco Grande-	3000°Luce Calda	F	>0,5	65W Tradizionale	10	50
● HE025	9	860	E27 -Attacco Grande-	4000°Luce Naturale	F	>0,5	65W Tradizionale	10	50
● HE179	9	860	E27 -Attacco Grande-	6000°Luce Fredda	F	>0,5	65W Tradizionale	10	50

- ACCENSIONE AUTOMATICA NELLE ORE NOTTURNE E SPEGNIMENTO NELLE ORE DIURNE.
- RISPARMIO ENERGETICO 86%.
- DURATA DI VITA MEDIA 25.000 ORE.





## GOCCIA A60 LED

CODICE	WATT	LUMEN	ATTACCO	KELVIN	ENERGY CLASS	DF	EQUIVALENTE	Lampadario	
								INNER	MASTER
● HE001	9	820	E27 -Attacco Grande-	3000°Luce Calda	F	>0,7	65W Tradizionale	10	100
● HE002	9	820	E27 -Attacco Grande-	4000°Luce Naturale	F	>0,7	65W Tradizionale	10	100
● HE003	9	820	E27 -Attacco Grande-	6000°Luce Fredda	F	>0,7	65W Tradizionale	10	100

- RISPARMIO ENERGETICO 86%.  
- DURATA DI VITA MEDIA 25.000 ORE.





60 mm  
110 mm

**E27**  
Attacco Grande

Angolo Luce  
270°

≥25.000x

Durata  
25.000 ore

V  
220/240V

Hertz  
50/60Hz



## GOCCIA A60 LED

CODICE	WATT	LUMEN	ATTACCO	KELVIN	ENERGY CLASS	DF	EQUIVALENTE	Lampadario	
								INNER	MASTER
● HE004	11	1055	E27 -Attacco Grande-	3000°Luce Calda	F	>0,7	75W Tradizionale	10	100
● HE005	11	1055	E27 -Attacco Grande-	4000°Luce Naturale	F	>0,7	75W Tradizionale	10	100
● HE006	11	1055	E27 -Attacco Grande-	6000°Luce Fredda	F	>0,7	75W Tradizionale	10	100

- RISPARMIO ENERGETICO 86%.
- DURATA DI VITA MEDIA 25.000 ORE.







60 mm  
125 mm

**E27**  
Attacco Grande

Angolo Luce  
270°

≥25.000x

Durata  
25.000 ore

V  
220/240V

Hertz  
50/60Hz

## GOCCIA A60 LED

CODICE	WATT	LUMEN	ATTACCO	KELVIN	ENERGY CLASS	DF	EQUIVALENTE	Lampadina	
								INNER	MASTER
● HE007	15	1521	E27 -Attacco Grande-	3000°Luce Calda	F	>0,7	90W Tradizionale	10	100
● HE008	15	1521	E27 -Attacco Grande-	4000°Luce Naturale	F	>0,7	90W Tradizionale	10	100
● HE009	15	1521	E27 -Attacco Grande-	6000°Luce Fredda	F	>0,7	90W Tradizionale	10	100

- RISPARMIO ENERGETICO 86%.  
- DURATA DI VITA MEDIA 25.000 ORE.





65 mm  
133 mm

**E27**  
Attacco Grande

Angolo Luce  
200°

≥20.000x

Durata  
20.000 ore

V  
220/240V

Hertz  
50/60Hz



## GOCCIA A65 LED

CODICE	WATT	LUMEN	ATTACCO	KELVIN	ENERGY CLASS	DF	EQUIVALENTE		
								INNER	MASTER
● HE022	18	1850	E27 -Attacco Grande-	3000°Luce Calda	<b>F</b>	>0,7	105W Tradizionale	10	50
● HE023	18	1850	E27 -Attacco Grande-	4000°Luce Naturale	<b>F</b>	>0,7	105W Tradizionale	10	50
● HE024	18	1850	E27 -Attacco Grande-	6000°Luce Fredda	<b>F</b>	>0,7	105W Tradizionale	10	50

- RISPARMIO ENERGETICO 86%.
- DURATA DI VITA MEDIA 20.000 ORE.





65 mm  
133 mm

**E27**  
Attacco Grande

Angolo Luce  
200°

≥20.000x

Durata  
20.000 ore

V  
220/240V

Hertz  
50/60Hz

## GOCCIA A65 LED

CODICE	WATT	LUMEN	ATTACCO	KELVIN	ENERGY CLASS	DF	EQUIVALENTE		
								INNER	MASTER
● HE210	20	2300	E27 -Attacco Grande-	3000°Luce Calda	E	>0,7	140W Tradizionale	10	50
● HE211	20	2300	E27 -Attacco Grande-	4000°Luce Naturale	E	>0,7	140W Tradizionale	10	50
● HE212	20	2300	E27 -Attacco Grande-	6000°Luce Fredda	E	>0,7	140W Tradizionale	10	50

- RISPARMIO ENERGETICO 86%.
- DURATA DI VITA MEDIA 20.000 ORE.





45 mm  
82 mm

**E14**  
Attacco Piccolo

Angolo Luce  
180°

≥25.000x

Durata  
25.000 ore

V  
220/240V

Hertz  
50/60Hz



## SFERETTA G45 LED

CODICE	WATT	LUMEN	ATTACCO	KELVIN	ENERGY CLASS	DF	EQUIVALENTE	Lampadina	
								INNER	MASTER
HE193	5	400	E14 -Attacco Piccolo-	3000°Luce Calda	<b>G</b>	>0,5	35W Tradizionale	10	100
HE194	5	400	E14 -Attacco Piccolo-	4000°Luce Naturale	<b>G</b>	>0,5	35W Tradizionale	10	100
HE195	5	400	E14 -Attacco Piccolo-	6000°Luce Fredda	<b>G</b>	>0,5	35W Tradizionale	10	100
HE016	7	600	E14 -Attacco Piccolo-	3000°Luce Calda	<b>F</b>	>0,5	45W Tradizionale	10	100
HE017	7	600	E14 -Attacco Piccolo-	4000°Luce Naturale	<b>F</b>	>0,5	45W Tradizionale	10	100
HE018	7	600	E14 -Attacco Piccolo-	6000°Luce Fredda	<b>F</b>	>0,5	45W Tradizionale	10	100
HE204	8	806	E14 -Attacco Piccolo-	3000°Luce Calda	<b>F</b>	>0,5	60W Tradizionale	10	100
HE205	8	806	E14 -Attacco Piccolo-	4000°Luce Naturale	<b>F</b>	>0,5	60W Tradizionale	10	100
HE206	8	806	E14 -Attacco Piccolo-	6000°Luce Fredda	<b>F</b>	>0,5	60W Tradizionale	10	100

- RISPARMIO ENERGETICO 86%.
- DURATA DI VITA MEDIA 25.000 ORE.





45 mm  
82 mm

**E27**  
Attacco Grande

Angolo Luce  
180°

≥25.000x

Durata  
25.000 ore

V  
220/240V

Hertz  
50/60Hz

## SFERETTA G45 LED

CODICE	WATT	LUMEN	ATTACCO	KELVIN	ENERGY CLASS	DF	EQUIVALENTE	Lampadina	
								INNER	MASTER
● HE190	5	400	E27 -Attacco Grande-	3000°Luce Calda	<b>G</b>	>0,5	35W Tradizionale	10	100
● HE191	5	400	E27 -Attacco Grande-	4000°Luce Naturale	<b>G</b>	>0,5	35W Tradizionale	10	100
● HE192	5	400	E27 -Attacco Grande-	6000°Luce Fredda	<b>G</b>	>0,5	35W Tradizionale	10	100
● HE013	7	600	E27 -Attacco Grande-	3000°Luce Calda	<b>F</b>	>0,5	45W Tradizionale	10	100
● HE014	7	600	E27 -Attacco Grande-	4000°Luce Naturale	<b>F</b>	>0,5	45W Tradizionale	10	100
● HE015	7	600	E27 -Attacco Grande-	6000°Luce Fredda	<b>F</b>	>0,5	45W Tradizionale	10	100
● HE201	8	806	E27 -Attacco Grande-	3000°Luce Calda	<b>F</b>	>0,5	60W Tradizionale	10	100
● HE202	8	806	E27 -Attacco Grande-	4000°Luce Naturale	<b>F</b>	>0,5	60W Tradizionale	10	100
● HE203	8	806	E27 -Attacco Grande-	6000°Luce Fredda	<b>F</b>	>0,5	60W Tradizionale	10	100

- RISPARMIO ENERGETICO 86%.  
- DURATA DI VITA MEDIA 25.000 ORE.





35 mm  
99 mm

**E14**  
Attacco Piccolo

Angolo Luce  
180°

≥25.000x

Durata  
25.000 ore

V  
220/240V

Hertz  
50/60Hz



## CANDELA C35 LED

CODICE	WATT	LUMEN	ATTACCO	KELVIN	ENERGY CLASS	DF	EQUIVALENTE	Lampadina	
								INNER	MASTER
HE196	5	400	E14 -Attacco Piccolo-	3000°Luce Calda	<b>G</b>	>0,5	35W Tradizionale	10	100
HE197	5	400	E14 -Attacco Piccolo-	4000°Luce Naturale	<b>G</b>	>0,5	35W Tradizionale	10	100
HE198	5	400	E14 -Attacco Piccolo-	6000°Luce Fredda	<b>G</b>	>0,5	35W Tradizionale	10	100
HE019	7	600	E14 -Attacco Piccolo-	3000°Luce Calda	<b>F</b>	>0,5	45W Tradizionale	10	100
HE020	7	600	E14 -Attacco Piccolo-	4000°Luce Naturale	<b>F</b>	>0,5	45W Tradizionale	10	100
HE021	7	600	E14 -Attacco Piccolo-	6000°Luce Fredda	<b>F</b>	>0,5	45W Tradizionale	10	100
HE207	8	800	E14 -Attacco Piccolo-	3000°Luce Calda	<b>F</b>	>0,5	60W Tradizionale	10	100
HE208	8	800	E14 -Attacco Piccolo-	4000°Luce Naturale	<b>F</b>	>0,5	60W Tradizionale	10	100
HE209	8	800	E14 -Attacco Piccolo-	6000°Luce Fredda	<b>F</b>	>0,5	60W Tradizionale	10	100

- RISPARMIO ENERGETICO 86%.
- DURATA DI VITA MEDIA 25.000 ORE.





**HQ**  
\* HIGH QUALITY \*

125 mm 120 mm  
173 mm  
156 mm

**E27**  
Attacco Grande

Angolo Luce  
270°

on/off  
≥25.000x

Durata  
25.000 ore

V  
220/240V

Hertz  
50/60Hz

## GLOBO G120/G125 LED

	CODICE	WATT	TIPOLOGIA	LUMEN	ATTACCO	KELVIN	ENERGY CLASS	DF	EQUIVALENTE	MASTER
●	HE128	18	G120	1850	E27 -Attacco Grande-	3000°Luce Calda	<b>F</b>	>0,7	110W Tradizionale	50
●	HE129	18	G120	1850	E27 -Attacco Grande-	4000°Luce Naturale	<b>F</b>	>0,7	110W Tradizionale	50
●	HE130	18	G120	1850	E27 -Attacco Grande-	6000°Luce Fredda	<b>F</b>	>0,7	110W Tradizionale	50
●	HE131	24	G125	2500	E27 -Attacco Grande-	3000°Luce Calda	<b>F</b>	>0,7	150W Tradizionale	50
●	HE132	24	G125	2500	E27 -Attacco Grande-	4000°Luce Naturale	<b>F</b>	>0,7	150W Tradizionale	50
●	HE136	24	G125	2500	E27 -Attacco Grande-	6000°Luce Fredda	<b>F</b>	>0,7	150W Tradizionale	50

- RISPARMIO ENERGETICO 86%.  
- DURATA DI VITA MEDIA 25.000 ORE.





**E14**  
Attacco Piccolo

Angolo Luce  
270°

≥25.000x

Durata  
25.000 ore

V  
220/240V

Hertz  
50/60Hz



**E27**  
Attacco Grande

Angolo Luce  
270°

≥25.000x

Durata  
25.000 ore

V  
220/240V

Hertz  
50/60Hz

## SPOT R50/R63/R80

CODICE	WATT	LUMEN	ATTACCO	KELVIN	ENERGY CLASS	DF	EQUIVALENTE	Lamp Icon	
								INNER	MASTER
● HE026	6	490	E14 -Attacco Piccolo-	3000°Luce Calda	<b>G</b>	>0,5	50W Tradizionale	10	100
● HE027	6	490	E14 -Attacco Piccolo-	4000°Luce Naturale	<b>G</b>	>0,5	50W Tradizionale	10	100
● HE029	8	720	E27 -Attacco Grande-	3000°Luce Calda	<b>F</b>	>0,5	60W Tradizionale	10	100
● HE030	8	720	E27 -Attacco Grande-	4000°Luce Naturale	<b>F</b>	>0,5	60W Tradizionale	10	100
● HE032	10	960	E27 -Attacco Grande-	3000°Luce Calda	<b>F</b>	>0,7	80W Tradizionale	10	100
● HE033	10	960	E27 -Attacco Grande-	4000°Luce Naturale	<b>F</b>	>0,7	80W Tradizionale	10	100
● HE056	15	1200	E27 -Attacco Grande-	3000°Luce Calda	<b>G</b>	>0,7	100W Tradizionale	20	40
● HE058	15	1200	E27 -Attacco Grande-	4000°Luce Naturale	<b>G</b>	>0,7	100W Tradizionale	20	40

- RISPARMIO ENERGETICO 86%.  
- DURATA DI VITA MEDIA 25.000 ORE.







37 mm  
115 mm

**E14**  
Attacco Piccolo

Angolo Luce  
180°

≥25.000x

Durata  
25.000 ore

V  
220/240V

Hertz  
50/60Hz



HE258  
HE259



HE260  
HE261



HE234  
HE235  
HE236

48 mm  
140 mm

**E27**  
Attacco Grande

Angolo Luce  
200°

≥20.000x

Durata  
20.000 ore

V  
220/240V

Hertz  
50/60Hz

## T35 - T45 - T50

CODICE	WATT	LUMEN	ATTACCO	KELVIN	ENERGY CLASS	DF	EQUIVALENTE	Lampadina	
								INNER	MASTER
● HE258	9	820	E14 -Attacco Piccolo-	3000°Luce Calda	F	>0,5	65W Tradizionale	10	100
● HE279	9	820	E14 -Attacco Piccolo-	4000°Luce Naturale	F	>0,5	65W Tradizionale	10	100
● HE259	9	820	E14 -Attacco Piccolo-	6000°Luce Fredda	F	>0,7	75W Tradizionale	10	100
● HE260	11	1055	E27 -Attacco Grande-	3000°Luce Calda	F	>0,5	65W Tradizionale	10	100
● HE280	11	1055	E27 -Attacco Grande-	4000°Luce Naturale	F	>0,7	75W Tradizionale	10	100
● HE261	11	1055	E27 -Attacco Grande-	6000°Luce Fredda	F	>0,7	75W Tradizionale	10	100
● HE234	15	1521	E27 -Attacco Grande-	3000°Luce Calda	F	>0,7	90W Tradizionale	10	100
● HE235	15	1521	E27 -Attacco Grande-	4000°Luce Naturale	F	>0,7	90W Tradizionale	10	100
● HE236	15	1521	E27 -Attacco Grande-	6000°Luce Fredda	F	>0,7	90W Tradizionale	10	100

- RISPARMIO ENERGETICO 86%.  
- DURATA DI VITA MEDIA 25.000 ORE.





50 mm

50 mm

**GU10**  
Attacco

Angolo Luce  
120°

≥25.000x

Durata  
25.000 ore

V  
220/240V

Hertz  
50/60Hz



## DICRO FLAT

CODICE	WATT	LUMEN	ATTACCO	KELVIN	ENERGY CLASS	DF	EQUIVALENTE		
								INNER	MASTER
● HE035	6	490	GU10 Dicro Flat	3000°Luce Calda	<b>G</b>	>0,5	40W Tradizionale	10	100
● HE036	6	490	GU10 Dicro Flat	4000°Luce Naturale	<b>G</b>	>0,5	40W Tradizionale	10	100
● HE037	6	490	GU10 Dicro Flat	6000°Luce Fredda	<b>G</b>	>0,5	40W Tradizionale	10	100
● HE038	8.5	806	GU10 Dicro Flat	3000°Luce Calda	<b>F</b>	>0,5	60W Tradizionale	10	100
● HE039	8.5	806	GU10 Dicro Flat	4000°Luce Naturale	<b>F</b>	>0,5	60W Tradizionale	10	100
● HE040	8.5	806	GU10 Dicro Flat	6000°Luce Fredda	<b>F</b>	>0,5	60W Tradizionale	10	100

- RISPARMIO ENERGETICO 86%.  
- DURATA DI VITA MEDIA 25.000 ORE.





## DICRO COB

CODICE	WATT	LUMEN	ATTACCO	KELVIN	ENERGY CLASS	DF	EQUIVALENTE	Lampadina	
								INNER	MASTER
● HE218	6	450	GU10 Dicro COB	3000°Luce Calda	<b>F</b>	>0,5	40W Tradizionale	10	100
● HE219	6	450	GU10 Dicro COB	4000°Luce Naturale	<b>F</b>	>0,5	40W Tradizionale	10	100
● HE220	6	450	GU10 Dicro COB	6000°Luce Fredda	<b>F</b>	>0,5	40W Tradizionale	10	100
● HE215	8	690	GU10 Dicro COB	3000°Luce Calda	<b>F</b>	>0,5	60W Tradizionale	10	100
● HE216	8	690	GU10 Dicro COB	4000°Luce Naturale	<b>F</b>	>0,5	60W Tradizionale	10	100
● HE217	8	690	GU10 Dicro COB	6000°Luce Fredda	<b>F</b>	>0,5	60W Tradizionale	10	100

- RISPARMIO ENERGETICO 86%.  
- DURATA DI VITA MEDIA 25.000 ORE.





50 mm  
55 mm

**MR16**

Angolo Luce  
100°

≥25.000x

Durata  
25.000 ore

V  
12V

Hertz  
50/60Hz



## DICRO GU5.3 LED

CODICE	WATT	LUMEN	ATTACCO	KELVIN	ENERGY CLASS	DF	EQUIVALENTE		
								INNER	MASTER
● HE174	6	600	MR16	3000°Luce Calda	<b>G</b>	>0,5	60W Tradizionale	10	100
● HE175	6	600	MR16	4000°Luce Naturale	<b>G</b>	>0,5	60W Tradizionale	10	100
● HE176	6	600	MR16	6000°Luce Fredda	<b>G</b>	>0,5	60W Tradizionale	10	100

- RISPARMIO ENERGETICO 86%.
- DURATA DI VITA MEDIA 25.000 ORE.





**J78 - J118 LED**

CODICE	WATT	LUMEN	ATTACCO	KELVIN	ENERGY CLASS	DF	EQUIVALENTE	Lampadina	
								INNER	MASTER
● HE231	4	470	R7S	3000°Luce Calda	E	>0,5	50W Tradizionale	10	100
● HE232	8.5	1050	R7S	3000°Luce Calda	E	>0,7	100W Tradizionale	10	100

- RISPARMIO ENERGETICO 86%.  
- DURATA DI VITA MEDIA 25.000 ORE.





- 
- 
- 
- 
- 
- 
- 



## G4 LED

	CODICE	WATT	LUMEN	ATTACCO	MISURE	KELVIN	ENERGY CLASS	DF	EQUIVALENTE	INNER	MASTER
●	HE266	1	90	G4	10x34mm	3000°Luce Calda	E	>0,5	25W Tradizionale	10	50
●	HE267	1	90	G4	10x34mm	3000°Luce Calda	E	>0,5	25W Tradizionale	10	50
●	HE268	1	90	G4	10x34mm	4000°Luce Naturale	E	>0,5	25W Tradizionale	10	50
●	HE269	1	90	G4	10x34mm	6000°Luce Fredda	E	>0,5	25W Tradizionale	10	50
●	HE270	1,5	150	G4	10x37mm	3000°Luce Calda	E	>0,5	25W Tradizionale	10	50
●	HE271	1,5	150	G4	10x37mm	4000°Luce Naturale	E	>0,5	25W Tradizionale	10	50
●	HE272	1,5	150	G4	10x37mm	6000°Luce Fredda	E	>0,5	25W Tradizionale	10	50
●	HE273	2	200	G4	13x41mm	3000°Luce Calda	E	>0,5	25W Tradizionale	10	50
●	HE274	2	200	G4	13x41mm	4000°Luce Naturale	E	>0,5	25W Tradizionale	10	50
●	HE275	2	200	G4	13x41mm	6000°Luce Fredda	E	>0,5	25W Tradizionale	10	50
●	HE276	3	350	G4	16x47mm	3000°Luce Calda	E	>0,5	40W Tradizionale	10	50
●	HE277	3	350	G4	16x47mm	4000°Luce Naturale	E	>0,5	40W Tradizionale	10	50
●	HE278	3	350	G4	16x47mm	6000°Luce Fredda	E	>0,5	40W Tradizionale	10	50

- RISPARMIO ENERGETICO 86%.  
- DURATA DI VITA MEDIA 25.000 ORE.



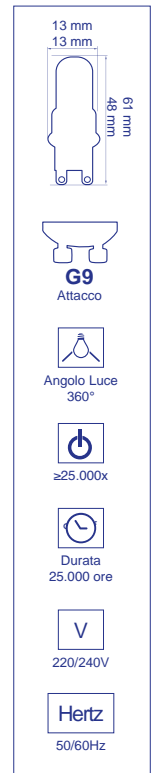

## G9 LED

CODICE	WATT	LUMEN	ATTACCO	KELVIN	ENERGY CLASS	DF	EQUIVALENTE	Lampadina	
								INNER	MASTER
● HE262	2	250	G9	3000°Luce Calda	E	>0,5	25W Tradizionale	10	50
● HE145	2	250	G9	4000°Luce Naturale	E	>0,5	25W Tradizionale	10	50
● HE263	2	250	G9	6000°Luce Fredda	E	>0,5	25W Tradizionale	10	50
● HE264	4	470	G9	3000°Luce Calda	E	>0,5	40W Tradizionale	10	50
● HE146	4	470	G9	4000°Luce Naturale	E	>0,5	40W Tradizionale	10	50
● HE265	4	470	G9	6000°Luce Fredda	E	>0,5	40W Tradizionale	10	50

- RISPARMIO ENERGETICO 86%.  
- DURATA DI VITA MEDIA 25.000 ORE.





18,9 mm  
16 mm  
16 mm

68 mm  
67 mm  
54 mm

**E14**  
Attacco Piccolo

Angolo Luce  
180°

≥25.000x

Durata  
25.000 ore

V  
220/240V

Hertz  
50/60Hz

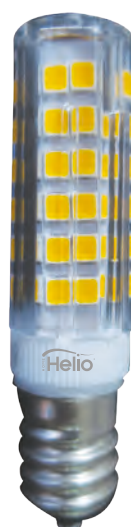

HE151

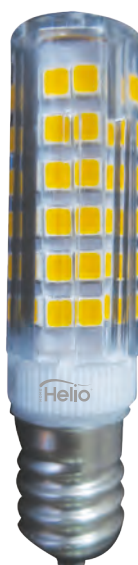

HE152



HE156

## TUBOLARE E14 LED

CODICE	WATT	LUMEN	ATTACCO	KELVIN	ENERGY CLASS	DF	EQUIVALENTE	Lampadario	
								INNER	MASTER
HE151	3	350	E14 -Attacco Piccolo-	4000°Luce Naturale	F	>0,5	30W Tradizionale	10	100
HE152	4	450	E14 -Attacco Piccolo-	4000°Luce Naturale	F	>0,5	40W Tradizionale	10	100
HE156	7	800	E14 -Attacco Piccolo-	4000°Luce Naturale	F	>0,5	80W Tradizionale	10	100

- RISPARMIO ENERGETICO 86%.
- DURATA DI VITA MEDIA 25.000 ORE.





*filo* **LED**  
HIGH POWER



*filo* **LED**  
HIGH POWER

- 60 mm (width)
- 106 mm (height)
- E27 Attacco Grande
- Angolo Luce 330°
- ≥20.000x (lifetime)
- Durata 20.000 ore
- V 220/240V
- Hertz 50/60Hz



## GOCCIA FILO LED A60

CODICE	WATT	LUMEN	ATTACCO	KELVIN	ENERGY CLASS	TIPOLOGIA	DF	EQUIVALENTE	Lampadario	
									INNER	MASTER
HE158	8	1055	E27	3000°Luce Calda	E	Vetro Clear	>0,5	75W Tradizionale	10	100
HE159	9	1200	E27	3000°Luce Calda	E	Vetro Clear	>0,5	90W Tradizionale	10	100
HE256	9	1200	E27	3000°Luce Calda	E	Vetro Frosted	>0,5	90W Tradizionale	10	100
HE170	11	1521	E27	3000°Luce Calda	D	Vetro Clear	>0,7	105W Tradizionale	10	100
HE257	11	1521	E27	3000°Luce Calda	D	Vetro Frosted	>0,7	105W Tradizionale	10	100

- RISPARMIO ENERGETICO 86%.  
- DURATA DI VITA MEDIA 20.000 ORE.



## SFERETTA FILO LED P45

CODICE	WATT	LUMEN	ATTACCO	KELVIN	ENERGY CLASS	TIPOLOGIA	DF	EQUIVALENTE	Lampadina	
									INNER	MASTER
● HE182	4	470	E14	3000°Luce Calda	E	Vetro Clear	>0,5	40W Tradizionale	10	100
● HE183	4	470	E14	3000°Luce Calda	E	Vetro Frosted	>0,5	40W Tradizionale	10	100
● HE160	6	806	E14	3000°Luce Calda	E	Vetro Clear	>0,5	60W Tradizionale	10	100
● HE161	6	806	E14	3000°Luce Calda	E	Vetro Frosted	>0,5	60W Tradizionale	10	100

- RISPARMIO ENERGETICO 86%.  
- DURATA DI VITA MEDIA 20.000 ORE.



*filo* **LED**  
HIGH POWER

- 45 mm (width)
- 80 mm (height)
- E27 Attacco Grande
- Angolo Luce 330°
- ≥20.000x (lifetime)
- Durata 20.000 ore
- V 220/240V
- Hertz 50/60Hz



## SFERETTA FILO LED P45

CODICE	WATT	LUMEN	ATTACCO	KELVIN	ENERGY CLASS	TIPOLOGIA	DF	EQUIVALENTE	Lamp Type	
									INNER	MASTER
● HE184	4	470	E27	3000°Luce Calda	E	Vetro Clear	>0,5	40W Tradizionale	10	100
● HE185	4	470	E27	3000°Luce Calda	E	Vetro Frosted	>0,5	40W Tradizionale	10	100
● HE162	6	806	E27	3000°Luce Calda	E	Vetro Clear	>0,5	60W Tradizionale	10	100
● HE163	6	806	E27	3000°Luce Calda	E	Vetro Frosted	>0,5	60W Tradizionale	10	100

- RISPARMIO ENERGETICO 86%.  
- DURATA DI VITA MEDIA 20.000 ORE.



35 mm  
88 mm

**E14**  
Attacco Piccolo

Angolo Luce  
330°

≥20.000x

Durata  
20.000 ore

V  
220/240V

Hertz  
50/60Hz

**CANDELA FILO LED C35**

CODICE	WATT	LUMEN	ATTACCO	KELVIN	ENERGY CLASS	TIPOLOGIA	DF	EQUIVALENTE	Candela	
									INNER	MASTER
● HE186	4	470	E14	3000°Luce Calda	E	Vetro Clear	>0,5	40W Tradizionale	10	100
● HE187	4	470	E14	3000°Luce Calda	E	Vetro Frosted	>0,5	40W Tradizionale	10	100
● HE164	6	806	E14	3000°Luce Calda	E	Vetro Clear	>0,5	60W Tradizionale	10	100
● HE165	6	806	E14	3000°Luce Calda	E	Vetro Frosted	>0,5	60W Tradizionale	10	100

- RISPARMIO ENERGETICO 86%.  
- DURATA DI VITA MEDIA 20.000 ORE.

CE ErP RoHS NO DIMMERABILE UV stop

NON CONTIENE MERCURIO NO USO ESTERNO

*filo* **LED**  
HIGH POWER

35 mm  
117 mm

**E14**  
Attacco Piccolo

Angolo Luce  
330°

≥20.000x

Durata  
20.000 ore

V  
220/240V

Hertz  
50/60Hz



## SOFFIO DI VENTO FILO LED CA35

CODICE	WATT	LUMEN	ATTACCO	KELVIN	ENERGY CLASS	TIPOLOGIA	DF	EQUIVALENTE	INNESTO	
									INNER	MASTER
● HE167	4	470	E14	3000°Luce Calda	E	Vetro Clear	>0,5	40W Tradizionale	10	100
● HE168	4	470	E14	3000°Luce Calda	E	Vetro Frosted	>0,5	40W Tradizionale	10	100
● HE166	6	806	E14	3000°Luce Calda	E	Vetro Clear	>0,5	60W Tradizionale	10	100
● HE169	6	806	E14	3000°Luce Calda	E	Vetro Frosted	>0,5	60W Tradizionale	10	100

- RISPARMIO ENERGETICO 86%.  
- DURATA DI VITA MEDIA 20.000 ORE.



64 mm  
140 mm

**E27**  
Attacco Grande

Angolo Luce  
330°

≥20.000x

Durata  
20.000 ore

V  
220/240V

Hertz  
50/60Hz

**ST64 FILO LED**

CODICE	WATT	LUMEN	ATTACCO	KELVIN	ENERGY CLASS	DF	EQUIVALENTE	Lampadina	
								INNER	MASTER
HE255	9	1055	E27 -Attacco Grande-	2200°Luce Calda	<b>F</b>	>0,5	85W Tradizionale	10	100

- RISPARMIO ENERGETICO 85%.
- DURATA DI VITA MEDIA 20.000 ORE.

*filo* **LED**  
HIGH POWER



## GLOBO FILO LED G120

CODICE	WATT	LUMEN	ATTACCO	KELVIN	ENERGY CLASS	TIPOLOGIA	DF	EQUIVALENTE	Lampadina	
									INNER	MASTER
● HE188	9	1200	E27	3000°Luce Calda	E	Vetro Clear	>0,5	85W Tradizionale	1	20
● HE189	9	900	E27	3000°Luce Calda	F	Vetro Amber	>0,5	70W Tradizionale	1	20

- RISPARMIO ENERGETICO 86%.  
- DURATA DI VITA MEDIA 20.000 ORE.





## TUBOLARE FILO LED T30 - T45

CODICE	WATT	LUMEN	ATTACCO	KELVIN	ENERGY CLASS	DF	EQUIVALENTE	Lamp Type	
								INNER	MASTER
● HE238	7	1000	E14 -Attacco Piccolo-	3000°Luce Calda	<b>D</b>	>0,5	60W Tradizionale	10	100
● HE239	9	1200	E27 -Attacco Grande-	3000°Luce Calda	<b>E</b>	>0,5	75W Tradizionale	10	100

- RISPARMIO ENERGETICO 86%.  
- DURATA DI VITA MEDIA 20.000 ORE.







**TUBO LED T8 GLASS SMD2835**

CODICE	WATT	LUMEN	ATTACCO	KELVIN	ENERGY CLASS	MISURE	DF	EQUIVALENTE	Lamp Type	
									INNER	MASTER
● HE041	9	900	G13	4000°Luce Naturale	F	600mm	>0,5	18W Tradizionale	10	30
● HE042	9	900	G13	6000°Luce Fredda	F	600mm	>0,5	18W Tradizionale	10	30
● HE043	18	1850	G13	4000°Luce Naturale	F	1200mm	>0,7	36W Tradizionale	10	30
● HE044	18	1850	G13	6000°Luce Fredda	F	1200mm	>0,7	36W Tradizionale	10	30
● HE045	24	2500	G13	4000°Luce Naturale	F	1500mm	>0,7	58W Tradizionale	10	30
● HE046	24	2500	G13	6000°Luce Fredda	F	1500mm	>0,7	58W Tradizionale	10	30

- RISPARMIO ENERGETICO 86%.  
- DURATA DI VITA MEDIA 20.000 ORE.

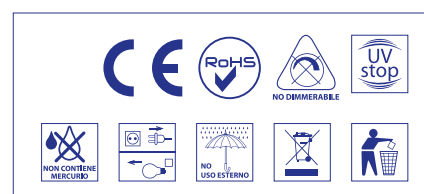

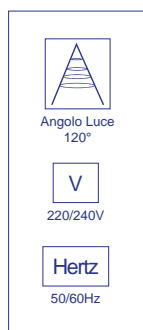

## RONDÒ

CODICE	LED	WATT	DIAMETRO	FORO	LUMEN	KELVIN	ENERGY CLASS	INSTALLAZIONE	
								INNER	MASTER
● HE650	30 PCS SMD	6	Ø118	Ø100	540	4000°Luce Naturale	F	10	40
● HE651	30 PCS SMD	6	Ø118	Ø100	540	6000°Luce Fredda	F	10	40
● HE652	60 PCS SMD	12	Ø167	Ø150	1200	4000°Luce Naturale	F	10	30
● HE653	60 PCS SMD	12	Ø167	Ø150	1200	6000°Luce Fredda	F	10	30
● HE654	90 PCS SMD	18	Ø221	Ø200	1800	4000°Luce Naturale	F	10	20
● HE655	90 PCS SMD	18	Ø221	Ø200	1800	6000°Luce Fredda	F	10	20

- 220-240 VOLTS
- GRADI: 120°
- PF: ≥0,9
- CRI: ≥80
- CORPO IN ALLUMINIO BIANCO
- COLORE: BIANCO
- DRIVER ISOLATO





## QUADROTTO

CODICE	LED	WATT	MISURE	FORO	LUMEN	KELVIN	ENERGY CLASS	Cassa	
								INNER	MASTER
● HE656	30 PCS SMD	6	116x116 mm	100x100 mm	540	4000°Luce Naturale	F	10	40
● HE657	30 PCS SMD	6	116x116 mm	100x100 mm	540	6000°Luce Fredda	F	10	40
● HE658	60 PCS SMD	12	167x167 mm	150x150 mm	1200	4000°Luce Naturale	F	10	30
● HE659	60 PCS SMD	12	167x167 mm	150x150 mm	1200	6000°Luce Fredda	F	10	30
● HE660	90 PCS SMD	18	219x219 mm	200x200 mm	1800	4000°Luce Naturale	F	10	20
● HE661	90 PCS SMD	18	219x219 mm	200x200 mm	1800	6000°Luce Fredda	F	10	20

- 220-240 VOLTS
- GRADI: 120°
- PF: ≥0,9
- CRI: ≥80
- CORPO IN ALLUMINIO BIANCO
- COLORE: BIANCO
- DRIVER ISOLATO







## NINJA LED TONDO/OVALE

CODICE	WATT	LUMEN	COLORE	TIPOLOGIA	KELVIN	ENERGY CLASS	DF	INNESTO	
								INNER	MASTER
HE141	14	1000	Bianca	Tonda	4000°Luce Naturale	<b>G</b>	≥0,7	1	25
HE142	14	1000	Bianca	Ovale	4000°Luce Naturale	<b>G</b>	≥0,7	1	25

SPECIFICHE DEI PRODOTTI: CORPO IN POLICARBONATO - SCHERMO OPALE

## GHIERE INTERCAMBIABILI

CODICE	DESCRIZIONE	INNESTO	
		INNER	MASTER
HE153	Ghiera ovale nera	1	25
HE154	Ghiera tonda nera	1	25

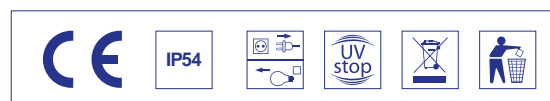

LINEALED

uniKa

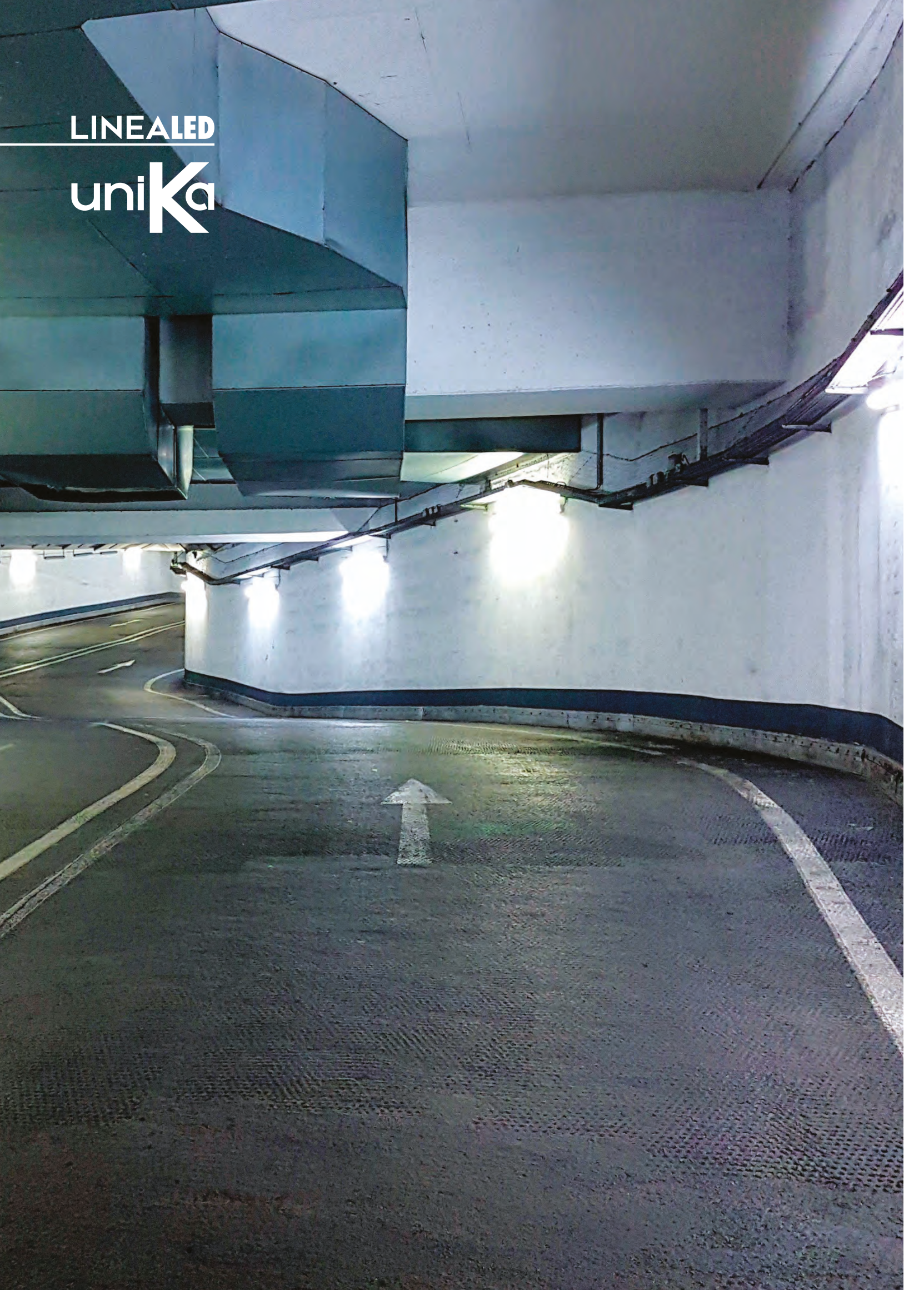





HE127

## PLAFONIERA STAGNA IP65

CORPO E DIFFUSORE IN POLICARBONATO  
CABLATA SINGOLO LATO PER 1 TUBO LED

CODICE	ARTICOLO	DESCRIZIONE	MASTER
HE121	Unika118	Plafoniera Stagna Cabl.Tubo Led 60 cm	15

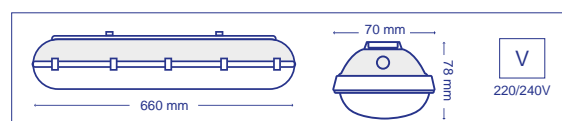

CODICE	ARTICOLO	DESCRIZIONE	MASTER
HE123	Unika136	Plafoniera Stagna Cabl.Tubo Led 120 cm	15

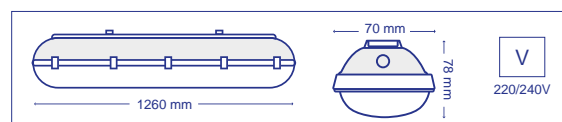

CODICE	ARTICOLO	DESCRIZIONE	MASTER
HE125	Unika158	Plafoniera Stagna Cabl.Tubo Led 150 cm	15

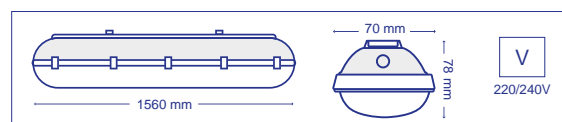

## CABLATA SINGOLO LATO PER 2 TUBI LED

CODICE	ARTICOLO	DESCRIZIONE	MASTER
HE122	Unika218	Plafoniera Stagna Cabl. 2 Tubi Led 60 cm	15

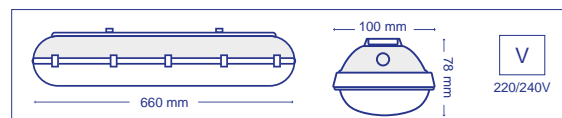

CODICE	ARTICOLO	DESCRIZIONE	MASTER
HE124	Unika236	Plafoniera Stagna Cabl. 2 Tubi Led 120 cm	10

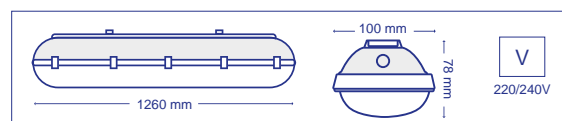

CODICE	ARTICOLO	DESCRIZIONE	MASTER
HE126	Unika258	Plafoniera Stagna Cabl. 2 Tubi Led 150 cm	10

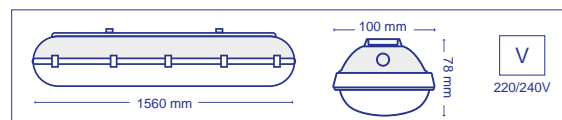

## CLIPS IN METALLO

CODICE	DESCRIZIONE	MASTER
HE127	Clips in Metallo - 10 pezzi	10







**JAMMY WHITE SENSOR** 

CODICE	LED	WATT	MISURE	LUMEN	KELVIN	ENERGY CLASS	INSTALLATION	
							INNER	MASTER
HE677	36 PCS SMD	30	14,5x11,5x4,5 cm	2400	6000°Luce Fredda	F	10	20
HE683	70 PCS SMD	50	19,5x13,5x6,5 cm	4000	6000°Luce Fredda	F	10	20

- 220-240 VOLTS
- GRADI: 120°
- CORPO IN ALLUMINIO BIANCO
- COLORE: BIANCO





## JAMMY WHITE IP65

CODICE	LED	WATT	MISURE	LUMEN	KELVIN	ENERGY CLASS	Lamp Type	
							INNER	MASTER
● HE662	13 PCS SMD	10	10,5x9x4,5 cm	800	4000°Luce Naturale	F	10	40
● HE663	26 PCS SMD	20	12x10,5x4,5 cm	1600	4000°Luce Naturale	F	10	40
● HE664	36 PCS SMD	30	14,5x11,5x4,5 cm	2400	4000°Luce Naturale	F	10	20
● HE665	70 PCS SMD	50	19,5x13,5x6,5 cm	4000	4000°Luce Naturale	F	10	20
● HE666	117 PCS SMD	100	28,5x20x6,5 cm	8200	4000°Luce Naturale	F	1	10
● HE679	13 PCS SMD	10	10,5x9x4,5 cm	800	6000°Luce Fredda	F	10	40
● HE680	26 PCS SMD	20	12x10,5x4,5 cm	1600	6000°Luce Fredda	F	10	40
● HE670	36 PCS SMD	30	14,5x11,5x4,5 cm	2400	6000°Luce Fredda	F	10	20
● HE671	70 PCS SMD	50	19,5x13,5x6,5 cm	4000	6000°Luce Fredda	F	10	20
● HE672	117 PCS SMD	100	28,5x20x6,5 cm	8200	6000°Luce Fredda	F	1	10

- 220-240 VOLTS
- GRADI: 120°
- CORPO IN ALLUMINIO BIANCO
- COLORE: BIANCO





**JAMMY BLACK** 

CODICE	LED	WATT	MISURE	LUMEN	KELVIN	ENERGY CLASS		
							INNER	MASTER
● HE681	36 PCS SMD	30	14,5x11,5x4,5 cm	2400	4000°Luce Naturale	<b>F</b>	10	20
● HE676	70 PCS SMD	50	19,5x13,5x6,5 cm	4000	4000°Luce Naturale	<b>F</b>	10	20
● HE682	117 PCS SMD	100	28,5x20x6,5 cm	8000	4000°Luce Naturale	<b>F</b>	1	10
● HE667	36 PCS SMD	30	14,5x11,5x4,5 cm	2400	6000°Luce Fredda	<b>F</b>	10	20
● HE668	70 PCS SMD	50	19,5x13,5x6,5 cm	4000	6000°Luce Fredda	<b>F</b>	10	20
● HE669	117 PCS SMD	100	28,5x20x6,5 cm	8200	6000°Luce Fredda	<b>F</b>	1	10

- 220-240 VOLTS
- GRADI: 120°
- CORPO IN ALLUMINIO NERO
- COLORE: NERO



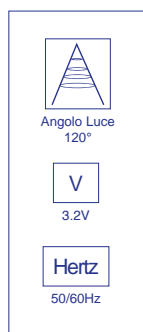

## SOLAIA

CODICE	LED	WATT	PANNELLO	FARO	BATTERIA	LUMEN	KELVIN	ENERGY CLASS	WEEE	
									INNER	MASTER
HE690	60 PCS SMD 2835	50	29x35 cm	19 x17 cm	10 AH	7500	4000°Luce Naturale	D	1	1
HE691	100 PCS SMD 2835	100	35x35 cm	23,5x18 cm	20 AH	15.000	4000°Luce Naturale	D	1	1
HE692	200 PCS SMD 2835	200	35x53 cm	36,3x26 cm	25 AH	30.000	4000°Luce Naturale	D	www	1

- CORPO IN ALLUMINIO NERO
- BATTERIA: LIFEPO4, 32650 3.2V
- DURATA BATTERIA: 4/6 ORE







Angolo Luce  
120°



V  
220/240V



Hertz  
50/60Hz

## JAMMY COLORS **RGB**

CODICE	LED	WATT	MISURE		
				INNER	MASTER
HE684	36 PCS SMD	20	12,2x9,8x3,3 cm	10	20
HE685	84 PCS SMD	50	18,8x13,6x3,6 cm	10	20
HE686	168 PCS SMD	100	28x20,2x4 cm	1	10

- CORPO IN ALLUMINIO NERO



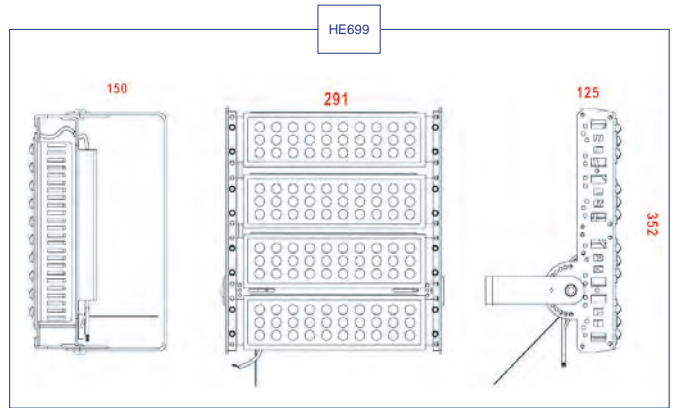
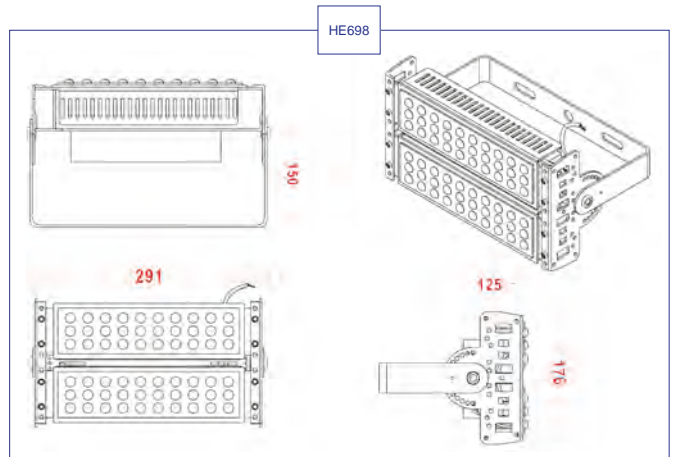
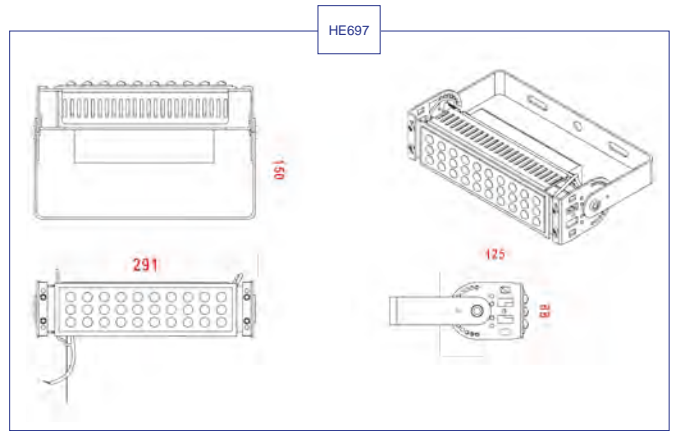





HE697



HE698



HE699

Angolo Luce  
60°-90°

V  
220/240V

Hertz  
50/60Hz

**HAPPY FLOOD** **RGB**

CODICE	LED	WATT	MISURE	KELVIN	ENERGY CLASS	Lamp Icon	
						INNER	MASTER
HE697	30 PCS SMD	50	291mm x 125mm x 88mm	6000°Luce Fredda	F	10	20
HE698	60 PCS SMD	100	291mm x 125mm x 176mm	6000°Luce Fredda	F	1	10
HE699	120 PCS SMD	200	291mm x 125mm x 352mm	6000°Luce Fredda	F	1	10



- 220-240 VOLTS
- GRADI: 120°
- PF: ≥0,9
- CRI: ≥80
- CORPO IN ALLUMINIO NERO
- COLORE: NERO

NO DIMMERABLE

CE

IP65

NON CONTIENE MERCURIO

UV stop

Waste disposal icons







Angolo Luce  
150°/75°





V  
220/240V



Hertz  
50/60Hz

**ARMATURA STRADALE** 

CODICE	LED	WATT	MISURE	LUMEN	KELVIN	ENERGY CLASS	 	
							INNER	MASTER
● HE251	48 PCS PHILIPS SMD 3030	25	50,7x21x14,3cm	3750	4000°Luce Naturale	D	10	20
● HE252	72 PCS PHILIPS SMD 3030	42	50,7x21x14,3cm	6300	4000°Luce Naturale	D	1	10
● HE253	72 PCS PHILIPS SMD 3030	55	50,7x21x14,3cm	8250	4000°Luce Naturale	D	1	10

- 220-240 VOLTS
- GRADI: 120°
- CORPO IN ALLUMINIO NERO
- COLORE: NERO



NO DIMMERABLE





IP65



NON CONTIENE  
MERCURIO





UV stop









HE600



HE601



HE602



HE603

## SPINA E PRESA MOBILE BIANCA

CODICE	AMPER	VOLT	COLORE	TIPOLOGIA	INNESTO	
					INNER	MASTER
○ HE600	10A	220 V	Bianco	Spina Mobile 10A 2P+T	10	100
○ HE601	16A	220 V	Bianco	Spina Mobile 16A 2P+T	10	100
○ HE602	10A	220 V	Bianco	Preso Mobile 10A 2P+T	10	100
○ HE603	10/16A	220 V	Bianco	Preso Mobile Bipasso 10/16A 2P+T	10	100

- SPINOTTI ATTIVI CON GUAINA ISOLANTE.  
 - MATERIALE IN POLICARBONATO IGNIFUGO.  
 - PACKAGING BULK.





HE604



HE619



HE605



HE628

## ADATTATORE SCHUKO/TRIPLO

CODICE	AMPER	VOLT	COLORE	TIPOLOGIA		
					INNER	MASTER
○ HE604	10A	220 V	Bianco	Adattatore Presa Schuko P30 con Spina 10A 2P+T	10	100
○ HE619	16A	220 V	Bianco	Adattatore Presa Schuko P30 con Spina 16A 2P+T	10	100
○ HE605	10/16A	220 V	Bianco	Adattatore Triplo 1 Presa Schuko, 2 Bprese 10/16A 2P+T con Spina 16A	10	100
○ HE628	16A	220 V	Bianco	Adattatore Triplo 3 Bprese 10/16A 2P+T con Spina 16A	10	100

- SPINOTTI ATTIVI CON GUAINA ISOLANTE.  
- MATERIALE IN POLICARBONATO IGNIFUGO.





HE618



HE629



HE630



HE636

## ADATTATORE - PRESA E SPINA SCHUKO

CODICE	AMPER	VOLT	COLORE	TIPOLOGIA		
					INNER	MASTER
○ HE618	10/16A	220 V	Bianco	Adattatore Spina Schuko con Bpresa 2P+T 10/16A	10	100
○ HE629	16A	220 V	Bianco	Adattatore Triplo Presa Schuko P40 2P+T 16A, 2 Bprese 2P+T 16A, Spina Schuko	10	100
○ HE630	10/16A	220 V	Bianco	Preso Volante Schuko con Bpresa 2P+T 10/16A	10	100
○ HE636	16A	220 V	Bianco	Spina Ultra Piatta Schuko 16A	10	100

- SPINOTTI ATTIVI CON GUAINA ISOLANTE.  
- MATERIALE IN POLICARBONATO IGNIFUGO.





HE620



HE621



HE622



HE623

## SPINA E PRESA MOBILE NERA

CODICE	AMPER	VOLT	COLORE	TIPOLOGIA	TIPOLOGIA	
					INNER	MASTER
● HE620	10A	220 V	Nero	Spina Mobile 10A 2P+T	10	100
● HE621	16A	220 V	Nero	Spina Mobile 16A 2P+T	10	100
● HE622	10A	220 V	Nero	Presa Mobile 10A 2P+T	10	100
● HE623	10/16A	220 V	Nero	Presa Mobile Bipasso 10/16A 2P+T	10	100

- SPINOTTI ATTIVI CON GUAINA ISOLANTE.  
- MATERIALE IN POLICARBONATO IGNIFUGO.







HE624



HE590



HE625



HE591

## ADATTATORE SCHUKO/TRIPLO

CODICE	AMPER	VOLT	COLORE	TIPOLOGIA	INNESTI	
					INNER	MASTER
● HE624	10A	220 V	Nero	Adattatore Presa Schuko P30 con Spina 10A 2P+T	10	100
● HE590	16A	220 V	Nero	Adattatore Presa Schuko P30 con Spina 16A 2P+T	10	100
● HE625	10/16A	220 V	Nera	Adattatore Triplo 1 Presa Schuko, 2 Bprese 10/16A 2P+T con Spina 16A	10	100
● HE591	16A	220 V	Nera	Adattatore Triplo 3 Bprese 10/16A 2P+T con Spina 16A	10	100

- SPINOTTI ATTIVI CON GUAINA ISOLANTE.  
- MATERIALE IN POLICARBONATO IGNIFUGO.



# ELECTRIC FLOW PACK



HE600/FP



HE601/FP



HE602/FP



HE603/FP



## SPINA E PRESA MOBILE BIANCA

	CODICE	AMPER	VOLT	COLORE	TIPOLOGIA	PACKAGING	
						INNER	MASTER
○	HE600/FP	10A	220 V	Bianco	Spina Mobile 10A 2P+T	36	144
○	HE601/FP	16A	220 V	Bianco	Spina Mobile 16A 2P+T	36	144
○	HE602/FP	10A	220 V	Bianco	Presa Mobile 10A 2P+T	36	144
○	HE603/FP	10/16A	220 V	Bianco	Presa Mobile Bipasso 10/16A 2P+T	36	144

- SPINOTTI ATTIVI CON GUAINA ISOLANTE.
- MATERIALE IN POLICARBONATO IGNIFUGO.
- FLOW PACK.





## ADATTATORE E PRESE SCHUKO/TRIPLO

	CODICE	AMPER	VOLT	COLORE	TIPOLOGIA	PACKAGING	
						INNER	MASTER
○	HE604/FP	10A	220 V	Bianco	Adattatore Presa Schuko P30 con Spina 10A 2P+T	36	144
○	HE619/FP	16A	220 V	Bianco	Adattatore Presa Schuko P30 con Spina 16A 2P+T	36	144
○	HE618/FP	10/16A	220 V	Bianco	Adattatore Spina Schuko con Bpresa 2P+T 10/16A	36	144
○	HE629/FP	16A	220 V	Bianco	Adattatore Triplo Presa Schuko P40 2P+T 16A, 2 Bprese 2P+T 16A, Spina Schuko	36	144
○	HE605/FP	10/16A	220 V	Bianco	Adattatore Triplo 1 Presa Schuko, 2 Bprese 10/16A 2P+T con Spina 16A	36	144
○	HE628/FP	16A	220 V	Bianco	Adattatore Triplo 3 Bprese 10/16A 2P+T con Spina 16A	36	144
○	HE630/FP	10/16A	220 V	Bianco	Presse volante Schuko con Bpresa 2P+T 10/16A	36	144

- SPINOTTI ATTIVI CON GUAINA ISOLANTE.  
- MATERIALE IN POLICARBONATO IGNIFUGO.  
- FLOW PACK.





HE612 **INTERRUTTORE DI PROTEZIONE SOVRACCARICO**



HE609



HE673



HE674

## MULTIPRESA POLIVALENTE INTERRUTTORE LUMINOSO

CODICE	AMPER	VOLT	COLORE	TIPOLOGIA	TIPOLOGIA	
					INNER	MASTER
○ HE612	10/16A	220V	Bianco	Interruttore Luminoso di Protezione Riarmabile - 2 Schuko + 4 Bprese 10/16A 2P+T - 1,5mt Cavo sez. 3x1mm <sup>2</sup> con Spina 16A	20	40
○ HE609	10/16A	220V	Bianco	Interruttore Luminoso - 1 Schuko + 2 Bpresa 10/16A 2P+T - 1,5mt Cavo sez. 3x1mm <sup>2</sup> con spina 16A	20	40
○ HE673	10/16A	220V	Bianco	Interruttore Luminoso 2 Schuko + Bpresa 10/16A 2P+T + 2USB- 1,5mt Cavo sez. 3x1mm <sup>2</sup> con spina 16A	20	40
○ HE674	10/16A	220V	Bianco	Interruttore Luminoso 4 Schuko + Bpresa 10/16A 2P+T - 2mt Cavo sez. 3x1mm <sup>2</sup> con spina 16A	20	40

### AVVERTENZE

- NON EFFETTUARE LAVORI SU PARTI ELETTRICHE SENZA AVER PRIMA TOLTO LA CORRENTE.
- NON SOTTOPORRE A STRAPPI O A TRAZIONI I CONDUTTORI ELETTRICI, SOSTITUIRLI QUANDO LOGORI.
- NON MANEGGIARE APPARECCHI ELETTRICI IN CONDIZIONI DI SCARSO ISOLAMENTO (MANI NUDE, SCALZI SU PAVIMENTO BAGNATO).
- NON DISPERDERE NELL'AMBIENTE.
- TENERE FUORI DALLA PORTATA DEI BAMBINI.





HE606



HE607



HE649



HE633



HE608

## MULTIPRESA POLIVALENTE INTERRUTTORE LUMINOSO

CODICE	AMPER	VOLT	COLORE	TIPOLOGIA	TIPOLOGIA	
					INNER	MASTER
○ HE606	10/16A	220V	Bianco	Interruttore Luminoso - 3 Schuko + Bpresa 10/16A 2P+T - 1,5mt Cavo sez. 3x1mm <sup>2</sup> con spina 16A	20	40
○ HE607	10/16A	220V	Bianco	Interruttore Luminoso - 4 Schuko + Bpresa 10/16A 2P+T - 1,5mt Cavo sez. 3x1mm <sup>2</sup> con spina 16A	20	40
○ HE649	10/16A	220V	Bianco	Interruttore Luminoso - 4 Schuko + Bpresa 10/16A 2P+T - 3mt Cavo sez. 3x1mm <sup>2</sup> con spina 16A	20	40
○ HE633	10/16A	220V	Bianco	Interruttore Luminoso - 5 Schuko + Bpresa 10/16A 2P+T - 1,5mt Cavo sez. 3x1mm <sup>2</sup> con spina 16A	20	40
○ HE608	10/16A	220V	Bianco	Interruttore Luminoso - 6 Schuko + Bpresa 10/16A 2P+T - 1,5mt Cavo sez. 3x1mm <sup>2</sup> con spina 16A	20	40

### AVVERTENZE

- NON EFFETTUARE LAVORI SU PARTI ELETTRICHE SENZA AVER PRIMA TOLTO LA CORRENTE.
- NON SOTTOPORRE A STRAPPI O A TRAZIONI I CONDUTTORI ELETTRICI, SOSTITUIRLI QUANDO LOGORI.
- NON MANEGGIARE APPARECCHI ELETTRICI IN CONDIZIONI DI SCARSO ISOLAMENTO (MANI NUDE, SCALZI SU PAVIMENTO BAGNATO).
- NON DISPREDERE NELL'AMBIENTE.
- TENERE FUORI DALLA PORTATA DEI BAMBINI.





## PROLUNGA LINEARE 3/5/10 METRI

CODICE	AMPER	VOLT	COLORE	TIPOLOGIA		
					INNER	MASTER
○ HE637	10/16A	220V	Bianco	3 METRI - Cavo sez. 3x1mm <sup>2</sup> Spina 16A con Presa Schuko + Bpresa 10/16A 2P+T	20	40
○ HE638	10/16A	220V	Bianco	5 METRI - Cavo sez. 3x1mm <sup>2</sup> Spina 16A con Presa Schuko + Bpresa 10/16A 2P+T	20	40
○ HE587	10/16A	220V	Bianco	10 METRI - Cavo sez. 3x1mm <sup>2</sup> Spina 16A con Presa Schuko + Bpresa 10/16A 2P+T	20	40

### AVVERTENZE

- NON EFFETTUARE LAVORI SU PARTI ELETTRICHE SENZA AVER PRIMA TOLTO LA CORRENTE.
- NON SOTTOPORRE A STRAPPI O A TRAZIONI I CONDUTTORI ELETTRICI, SOSTITUIRLI QUANDO LOGORI.
- NON MANEGGIARE APPARECCHI ELETTRICI IN CONDIZIONI DI SCARSO ISOLAMENTO (MANI NUDE, SCALZI SU PAVIMENTO BAGNATO).
- NON DISPERDERE NELL'AMBIENTE.
- TENERE FUORI DALLA PORTATA DEI BAMBINI.





## PROLUNGA LINEARE 3/5/10 METRI

	CODICE	AMPER	VOLT	COLORE	TIPOLOGIA		
						INNER	MASTER
○	HE634	10A	220V	Bianco	3 METRI - Cavo sez. 3x0,75mm <sup>2</sup> - Spina 10A con Presa 10A 2P+T	20	40
●	HE635	10A	220V	Nero	3 METRI - Cavo sez. 3x0,75mm <sup>2</sup> - Spina 10A con Presa 10A 2P+T	20	40
○	HE610	10/16A	220V	Bianco	3 METRI - Cavo sez. 3x1mm <sup>2</sup> - Spina 16A con Bpresa 10/16A 2P+T	20	40
●	HE616	10/16A	220V	Nero	3 METRI - Cavo sez. 3x1mm <sup>2</sup> - Spina 16A con Bpresa 10/16A 2P+T	20	40
○	HE611	10/16A	220V	Bianco	5 METRI - Cavo sez. 3x1mm <sup>2</sup> - Spina 16A con Bpresa 10/16A 2P+T	20	40
●	HE617	10/16A	220V	Nero	5 METRI - Cavo sez. 3x1mm <sup>2</sup> - Spina 16A con Bpresa 10/16A 2P+T	20	40
○	HE586	10/16A	220V	Bianco	10 METRI - Cavo sez. 3x1mm <sup>2</sup> - Spina 16A con Bpresa 10/16A 2P+T	20	40
●	HE585	10/16A	220V	Nero	10 METRI - Cavo sez. 3x1mm <sup>2</sup> - Spina 16A con Bpresa 10/16A 2P+T	20	40

### AVVERTENZE

- NON EFFETTUARE LAVORI SU PARTI ELETTRICHE SENZA AVER PRIMA TOLTO LA CORRENTE.
- NON SOTTOPORRE A STRAPPI O A TRAZIONI I CONDUTTORI ELETTRICI, SOSTITUIRLI QUANDO LOGORI.
- NON MANEGGIARE APPARECCHI ELETTRICI IN CONDIZIONI DI SCARSO ISOLAMENTO (MANI NUDE, SCALZI SU PAVIMENTO BAGNATO).
- NON DISPERDERE NELL'AMBIENTE.
- TENERE FUORI DALLA PORTATA DEI BAMBINI.





HE613



HE614

## AVVOLGICAVO 5/10 METRI

	CODICE	AMPER	VOLT	COLORE	TIPOLOGIA		
						INNER	MASTER
○	HE613	10/16A	220V	Nero	Avvolgicavo 5Mt - Protezione Sovraccarichi - 4 Schuko Bprese 2P+T 10/16A Cavo Sez. 3Gx1,0mm <sup>2</sup> Spina 16A	1	40
○	HE614	10/16A	220V	Nero	Avvolgicavo 10Mt - Protezione Sovraccarichi - 4 Schuko Bprese 2P+T 10/16A Cavo Sez. 3Gx1,0mm <sup>2</sup> Spina 16A	1	40







HE589



HE626



HE627

## AVVOLGICAVO 15/25 METRI

CODICE	AMPER	VOLT	COLORE	TIPOLOGIA		
					INNER	MASTER
● HE589	10/16A	220V	Nero	Avvolgicavo 15Mt - 4 Schuko Bprese 10/16A 2P+T, Cavo Sez. 3x1,5mm <sup>2</sup> Spina 16A	1	1
● HE626	10/16A	220V	Nero	Avvolgicavo 15Mt - 4 Schuko Bprese 10/16A 2P+T, Cavo Sez. 3X1,5mm <sup>2</sup> Spina 16A	1	6
● HE627	10/16A	220V	Nero	Avvolgicavo 25Mt - 4 Schuko Bprese 10/16A 2P+T, Cavo Sez. 3x1,5mm <sup>2</sup> Spina 16A	1	1





## NASTRO ADESIVO PER IMBALLAGGI

	CODICE	DIMENSIONI	METRI	COLORE	MASTER 
<input type="radio"/>	HE900	48mm x 100m x 48mic	100mt	Trasparente	200
<input checked="" type="radio"/>	HE901	48mm x 50m x 48mic	250mt	Marrone	200
<input type="radio"/>	HE902	48mm x 50m x 48mic	250mt	Trasparente	200





## NASTRO ISOLANTE PVC AUTOESTINGUENTE

CODICE	DIMENSIONI	COLORE	MASTER
● HE903	15mm x 10mt x 130mic	Nero	200
● HE904	19mm x 25mt x 130mic	Nero	200
● HE905	25mm x 25mt x 130mic	Nero	200
○ HE906	15mm x 10mt x 130mic	Bianco	100
○ HE907	19mm x 25mt x 130mic	Bianco	100
○ HE908	25mm x 25mt x 130mic	Bianco	100



# ESPOSITORI

ESPOSITORE DA TERRA A GANCI - 4 FILE - 2 SCOMPARTI A CASSETTO



HE880



HE880

# PACKAGING

## GOCCIA



# PACKAGING

## CANDELA - GU10

---



# PACKAGING

## SFERETTA

---



# PACKAGING

SPOT R80 - GLOBO



# PACKAGING

FILO LED: SFERETTA - CANDELA - GLOBO





Cloud

Vetturnos



SAFEVAY  
INTEGRATED SYSTEMS

6

HOME  
Helio



Cloud

HOME  
Helio

SAFEVAY  
INTEGRATED SYSTEMS

3

V





**SPONSOR**  
**NETTUNO B.C. SERIE A**









HELIO GROUP SRL  
SEDE LEGALE: VIA G. GOZZI, 55 - 00145 ROMA (RM)  
TELEFONO: 06 62290907 - INFO@HELIOGROUP.IT  
WWW.HELIOGROUP.IT